

SmartScoot™

World's Best Travel Mobility Scooter



USERS INSTRUCTION MANUAL

Version 1.8

IMP HOLDINGS, LLC
WWW.SMARTSCOOT.COM

WARNINGS AND DISCLAIMERS

STOP and read the Limited Warranty on pages 29-30 before proceeding any further. If you disagree with any of the terms and conditions contained on pages 29-30, you must submit a written request to info@SmartScoot.com for a Return Authorization within 3 days of delivery. Do not unpack or assemble the SmartScoot™. The scooter must be returned in its original box and in new and unused condition, accompanied by the original receipt.

WARNING - THE RISK OF INJURY

SmartScoot™ was designed to make every day mobility easy. However, there are certain risks that users should be aware of when operating a SmartScoot™ such as injury from loss of control, tipping over, collisions or falls. It is your responsibility to learn how to safely ride the SmartScoot™ to help reduce these risks.

Our website and support materials outline the potential hazards of driving the SmartScoot™. Prior to riding the SmartScoot™, take time to thoroughly read and understand all of these materials including this Users Instruction Manual which sets forth safety instructions. Any questions regarding information contained in this Manual, on our website, in support materials, about the SmartScoot™ and related equipment, and all other questions should be sent in writing to info@SmartScoot.com or called in to our customer service representatives at (855) 726-6866 / (855) SCOOT66.

DISCLAIMER: ENSURE THAT THE PRODUCT IS RIGHT FOR YOU

A mobility scooter is not a toy. It is an electrically powered scooter and failure to follow safe operating procedures and safety warnings at all times could result in serious personal injury or death in addition to the injury or death of others. Driving a mobility scooter requires a combination of healthy traits and abilities, including but not limited to: good vision; strength; coordination; balance and concentration. If you have these traits and abilities, you are on the right track. Additionally, to safely operate the SmartScoot™, you must be able to:

- Read and understand all SmartScoot™ reference materials, including this Users Instruction Manual and all SmartScoot™ safety instructions contained in this Manual.
- Stand and walk independently or with limited assistance.
- Have sufficient hand strength to operate the throttle and brake.
- Maintain and shift balance to accommodate inclines, declines and turns as described in the Users Instruction Manual and all SmartScoot™ safety instructions.
- Steer and control the mobility scooter.
- See pedestrians and vehicles.
- Judge speeds, distances and slopes.
- Recognize hazards and obstacles in your path.
- Be patient enough to slow down, stop and wait whenever necessary.
- Mount or dismount the mobility scooter without assistance or risk of falling.
- Easily get the mobility scooter in and out of its storage place.
- Use both hands on the handlebars.

TABLE OF CONTENTS

Congratulations on the purchase of your SmartScoot™. Please read this Users Instruction Manual carefully before attempting to operate your SmartScoot™. This Manual contains important information regarding the safe operation of your scooter including safety and training information, battery use and charging and maintenance of your scooter. Read, understand and pay careful attention to our safety and training sections and follow them diligently. Any questions regarding any information contained in this Manual or other questions in general should be sent in writing to info@SmartScoot.com or called in to our customer service representatives at (855) 726-6866 (855-SCOOT66).

CONTENTS

WARNINGS AND DISCLAIMERS	2
TABLE OF CONTENTS	3
SAFETY INSTRUCTIONS	4
SMARTSCOOT™ FEATURES.....	6
UNPACKING YOUR SMARTSCOOT™	7
ASSEMBLING THE SMARTSCOOT™	8
ADJUSTING YOUR SMARTSCOOT™	11
FOLDING AND LIFTING YOUR SCOOTER	14
OPERATING YOUR SMARTSCOOT™	16
GETTING STARTED - LEARNING TO DRIV.....	18
GETTING ABOUT WITH YOUR SMARTSCOOT™	20
AIR TRAVEL.....	23
SMARTSCOOT™ STORAGE ACCESSORIES.....	24
BATTERY AND BATTERY CHARGING	25
PRODUCT SPECIFICATIONS	28
LIMITED WARRANTY.....	29
TROUBLESHOOTING AND MAINTENANCE	31

SAFETY INSTRUCTIONS

The below instructions and tips will help you to operate the SmartScoot™ safely.

PLEASE NOTE - The SmartScoot™ scooter is designed to be used by one person at a time and is not recommended for any person younger than 16 years old.

- Read this Manual and all safety and training instructions and all warning labels before operating the SmartScoot™
- Do not carry passengers or exceed the maximum weight capacity.
- Do not mount or dismount the SmartScoot™ unless it is resting at a complete stop, parking brake engaged and is turned off.
- Comply with all local laws and regulations while operating the SmartScoot™.
- Check that all folding levers and clamps are securely locked before use.
- Always slow down before changing directions and turning.
- Always keep your feet on the foot rests when driving the SmartScoot™.
- Always approach small obstacles straight on and at slow speeds. Do not attempt to drive over curbs, potholes, puddles or any other road hazards. Use common sense when operating the SmartScoot™. Reckless driving can result in an accident!

SAFETY WARNINGS



Reduce speeds through turns or while changing directions.



The SmartScoot™ is designed to go over flat, paved or carpeted surfaces only. Do not attempt to go over curbs, through potholes, puddles or any other road hazard. You should not maneuver around these hazards, stop the scooter, dismount it and walk the scooter around the hazard. Attempting to go over hazards will cause the unit to tip over.



The SmartScoot™ is not designed to go up steep inclines. Attempting to drive up **steep** inclines can cause the unit to lose momentum.



The SmartScoot™ was designed for flat, paved or carpeted surfaces. Do not drive the unit on grass, gravel, or any other textured or bumpy surfaces.



Use caution when driving the scooter over wet surfaces. Avoid puddles or potential icy conditions. If rain cannot be avoided, reduce your speed and allow for more stopping distance.

SMARTSCOOT™ FEATURES

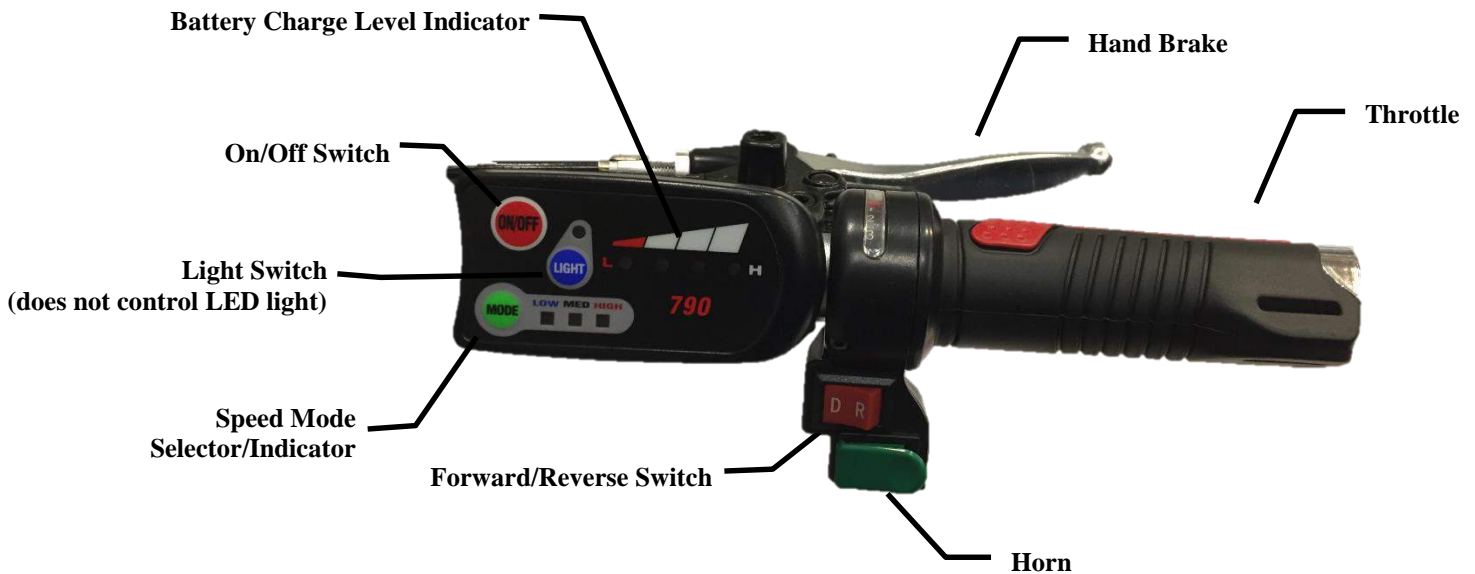

UNPACKING YOUR SMARTSCOOT™

The SmartScoot™ arrives in a strong dual walled carton. Carefully cut the packaging straps from the carton using scissors and then cut the packing tape to allow access. The scooter arrives fully folded. The package also includes the adjustable seat, battery charger and charging cord, removable basket, basket hardware, luggage rack and Allen wrenches. The battery and light may be shipped separately. Accordingly, you will find packaged:

- The Folded scooter
- The Adjustable Seat and Seat back
- The Battery (in some cases, the battery may be shipped separately)
- The Battery Charger and Charging Cord
- The Basket and Hardware
- The Luggage Rack
- LED Handlebar Light
- Allen Wrenches

REMOVING THE PRODUCT

Our product is carefully packaged to ensure that the SmartScoot™ arrives in perfect condition.

1. Using scissors, carefully cut the white wire ties from the product. **CAUTION – Do not cut the black wire ties.** These are used to route the wiring throughout the scooter.
2. Remove and discard all inner corrugated and other packing materials.
3. Lift the scooter by the center bar out of the box and place it on a level flat surface. Remove the rest of the items from the box making sure that the above items are present. Inspect all items before using and take full responsibility for assuring that the equipment is in good working order and is safe to use.
4. Your battery arrives half charged. Make sure it is fully charged before use. It will take about 5 hours for the initial charge.

PLEASE NOTE - Any and all returns must be authorized in advance. The original receipt is required for any and all returns. The scooter must be returned in its original box.

ASSEMBLING THE SMARTSCOOT™

CONNECTING THE REAR WHEELS

The rear wheels adjust to three different positions offering the user additional stability when using the SmartScoop™. The wider the wheel base, the more stable the scooter will be during use.

PLEASE NOTE – Even though the wider wheel base offers more stability, it also makes it more difficult to go through doorways. We recommend the middle setting.

1. Loosen the clamps at both ends of the rear axle by lifting up the levers on the clamps.
2. Remove the metal tubes protruding from the ends of the rear axle and discard them (these were used to protect the axle during shipping).
3. Insert the rear wheel with tubing into the opening of the rear axle until the hole of the tubing aligns with one of the three holes on the rear axle. The first hole is for the widest setting, the middle hole is for the medium setting and the third hole is for the narrowest setting.
4. Holding the button on the adjusting pin, slide the pin through the holes of the tubing and rear axle. Make sure to hold the button until the pin goes through both holes (front and back).
5. **PLEASE NOTE – The wheels must be at the same width setting on both sides. For example, the middle position on left means you have to be in the middle position on the right.**
6. Tighten the clamp by pushing down on the lever.
7. Repeat on the other side

WARNING – Prior to driving make sure that each side is in the same position, that the alignment pins are through both holes and that the clamps are tightened and secured.



SETTING UP THE STEERING COLUMN

1. Lift the steering column to its upright position until it locks in place.
2. Pull the latch upwards threading the bolt through the center of the locking system.
3. Turning the lever to the right or left, press down on the lever to secure the steering column.
4. The steering locking system may loosen with use. Check frequently and make sure it is tight.



CONNECTING THE SEAT

1. Take the seat back and slide it into the slot underneath the seat. Tighten the black knob to secure the seat back to the seat. Lift the seat back to its upright position. See Figure 1.
2. Find the seat post and remove the top locking pin from the post. To remove the pin, continually press down the small knob on the end of the pin until the pin is removed completely from the system. See Figure 2.
3. Insert the seat into the attached seat post. Turn the lever on the left while holding the screw on the right. This tightens the locking system. Grab hold of the lever and pull it forward until it tightens. **PLEASE NOTE – Over tightening the screw will make it difficult for you to tighten the handle. You might have to loosen the screw to adjust the tension. The system requires that you use some force to tighten the latch.**
4. Replace the locking pin into the top hole. Again, press down the small knob on the pin until the pin is through both holes in the post. Instructions for the seat level and seat back can be found in this Manual in the Adjusting Your SmartScoot™ section.



Figure 1



Figure 2

CONNECTING THE BATTERY

1. With the SmartScoot™ label facing on top and the battery label facing on the left side, carefully align and slide the battery pack downward making sure that it slides into place
2. Twist the top latch to secure the battery.
3. Insert the battery cord from the control panel box into the battery socket.
4. Turn the switch on the control panel box to the on position.



POSITIONING AND TIGHTENING THE BRAKE HANDLE

1. This process requires you to use the enclosed Allen wrench.
2. Sitting on the scooter, place your right hand on the throttle.
3. Next, lift the hand brake to a comfortable position on the handlebars. The recommended position is just below level from the throttle
4. Slide the Allen wrench into the bolt and tighten to secure.



FOOT RESTS

1. Pull down foot rests.

LED HEADLIGHT

1. The headlight is to be mounted on the handlebar and is operated independent of the throttle controls. The headlight should be used in dark conditions. Pressing the top of the headlight turns on the headlight and also changes its mode from flashing quickly, to flashing slowly, to on, to off. The “light” button on the control panel does not control this headlight.

ADJUSTING YOUR SMARTSCOOT™

With a handful of adjustable features, SmartScoot™ can accommodate almost any body type without compromising comfort or safety. The seat post and front steering column adjust vertically to fit the user's height, while a mesh seat backing shifts forward or backward to provide the right amount of support. Even the rear wheels offer flexibility. Three different settings are available – a bonus for users requiring additional stability while they drive.

ADJUSTING THE HANDLEBARS

SmartScoot™ allows you to adjust the height of the handlebars. Simply open the clamp by releasing the lever. Lift or lower the handlebars to a comfortable height. When at the desired height, push in the lever to tighten the clamp.

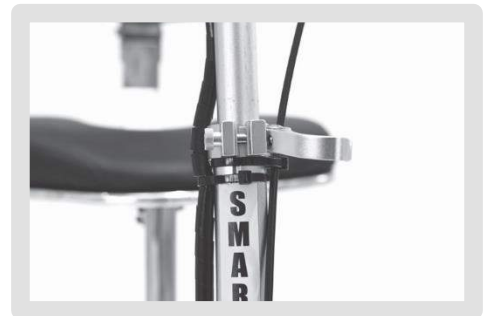

ADJUSTING THE SEAT

The SmartScoot™ seat can be adjusted in two ways for maximum comfort.

Seat Backrest

Slide the slotted bar on the bottom of the seat backrest into the slot on the bottom of the seat. Tighten the black knob once the desired seat back position is obtained.



Seat Height

The SmartScoot™ seat can be adjusted to three different heights located on the seat post. Please note that there are 4 holes on the seat post. The bottom 3 holes determine the seat height. The top hole is for seat security which is further discussed below.

1. Remove the seat from the SmartScoot™ by removing both pins from the seat post, releasing the lever which loosens the clamp.
2. Once the optimal seat height is determined, insert one of the adjusting pins into the hole by pressing on the small knob and pushing it through both holes of the attached seat post. Replace the seat onto the scooter.
3. Push in the lever which will tighten the clamp. If the clamp does not tighten, turn the lever on the left while holding the screw on the right. This tightens the locking system. Grab hold of the lever and pull it forward until it tightens. **PLEASE NOTE – Over tightening the screw will make it difficult for you to tighten the handle. You might have to loosen the screw to adjust tension. The system requires that you use some force to tighten the latch.**
4. Replace the locking pin into the top hole. Press down the small knob on the pin until the pin is through both holes in the post.



SEAT SECURITY

To ensure seat security while driving or lifting the SmartScoot™ the seat must be securely attached to the unit. There are two steps required to ensuring seat security.

1. Tighten the clamp by pushing in the lever.
2. Insert the security pin into the top hole of the scooter.

ADJUSTING THE REAR WHEELS

The rear wheels adjust to three different positions offering the user additional stability when using the SmartScoot™. The wider the wheel base, the more stable the scooter will be during use.

PLEASE NOTE – Even though the wider wheel base offers more stability, it also makes it more difficult to go through doorways. We recommend the middle setting.

1. Remove the two adjusting pins from the rear axle by pressing and holding the button on the pin and sliding it toward you.
2. Lift up the lever which loosens the clamps on the rear axle next to the wheels.
3. Remove both wheels from the scooter, as pictured below.
4. There are three holes on each side of the axle. The holes closest to the middle of the axle represent the narrowest position of the wheels. The wheelbase gets longer as you move towards the outer two holes. **PLEASE NOTE – Once you have determined the position of the wheels, it must be the same position on both sides. For example, the middle position on left means you have to be in the middle position on the right.**
5. Determine your desired position (narrow, middle, widest).
6. Slide the wheel and tubing back into the rear axle aligning the appropriate hole for the desired position, as pictured below.
7. Holding the button on the adjusting pin, slide the pin through the appropriate holes. Make sure you hold the button until the pin goes through both holes (front and back).
8. Tighten the clamp by pushing down on the lever.
9. Repeat on the other side

WARNING – Prior to driving make sure that each side is in the same position, that the alignment pins are through both holes and that the clamps are tightened and secured.



FOLDING AND LIFTING YOUR SCOOTER

SmartScoot™ was innovatively designed to be lightweight, foldable and easy to transport. The SmartScoot™ will fit in most cars and all SUV's, trucks and vans. The scooter can be folded and unfolded quickly without the use of any tools.

FOLD IT

SmartScoot™ offers two folding option positions to accommodate various types of spaces.

- **Position 1** allows the SmartScoot™ to fold down to its smallest size by removing the seat first. This size fits into most car trunks, SUV's, trucks and vans.
- **Position 2** allows the SmartScoot™ to remain in one piece. This size fits into most SUV's, trucks and vans.

Position 1 Directions

WARNING – IN THIS POSITION DO NOT LIFT THE SCOOTER BY THE STEERING COLUMN. USE TWO HANDS TO LIFT THE SCOOTER BY THE SEAT POST AND THE CENTER BAR.

1. Remove the seat by pulling the top security pin from the seat post and by opening the seat clamp lever. Lift the seat out of the seat post and replace the top security pin in its original position.
2. Using our Fold n Lock Technology™, fold down the front steering column by lifting the front lever, pulling the latch down through the notch and clamp. With one hand on the steering column use one finger from your opposite hand to slide the latch sideways until the steering column releases.
3. Do NOT attempt to lift the scooter by the steering column only. Use two hands and lift the scooter by the center bar. There is an enclosed Velcro strap that may be used to secure the center bar to the steering column.
4. To remove additional weight, you can also remove the battery from the scooter. Instructions for removing the battery from the scooter can be found in this Manual in the Battery and Battery Charging section.
5. Once your scooter is placed in your vehicle, engage the parking brake.



Position 2 Directions

1. Using our Fold n Lock Technology™, fold down the front steering column by lifting the front lever, pulling the latch down through the notch and clamp. With one hand on the steering column use one finger from your opposite hand to slide the latch sideways until the steering column releases.
2. Lower the steering column until the handlebars rest on the seat.
3. Lower the back rest of the seat onto the top of the handlebars, as pictured.
4. Once your scooter is placed in your vehicle, engage the parking brake.



WARNING – IN THIS POSITION DO NOT LIFT THE SCOOTER BY THE STEERING COLUMN. USE TWO HANDS TO LIFT THE SCOOTER BY THE SEAT POST AND THE CENTER BAR.

LIFT IT

SmartScoot™ only weighs just under 40 pounds when fully assembled, making it lightweight and easy to lift. However, for users who still require an even lighter load, SmartScoot™ can break down quickly and easily into as many as three lighter pieces. The heaviest piece weighs only 27 pounds, and even better, no tools are required to disassemble the scooter. Users can choose to remove just the seat or both the seat and the battery. It's entirely up to you. With three different options for lifting the SmartScoot™, transporting a mobility scooter has never been easier.

WARNING - Always lift the scooter by the center bar.

OPERATING YOUR SMARTSCOOT™

SmartScoot™ was designed to make everyday mobility easy. However, there are still certain risks that users should be aware of when operating a SmartScoot™ such as injury from loss of control, tipping over, collisions or falls. It is your responsibility to learn how to safely ride the SmartScoot™ to potentially reduce these risks. Our website and support materials outline the potential hazards of driving the SmartScoot™. Prior to riding the SmartScoot™ take time to read and understand all support materials including this Users Instruction Manual which contains safety instructions. **Any questions regarding any information contained in this Manual, our website, any support materials or any other general questions should be sent in writing to info@SmartScoot.com or called in to our customer service representatives at (855) 726-6866 (855-SCOOT66).**



CONTROL PANEL OPERATION FEATURES

1. On/Off Button

Located on the upper left side of the control panel, push in the on/off button to turn on the SmartScoot™ and push the button in again to turn off the SmartScoot™. Turn off your SmartScoot™ when it is not being operated to help preserve the battery life.

2. Speed Control

The green mode button located below the on/off button is the speed control. You can choose: low, with a maximum speed of 3 mph; med, with a maximum speed of 5 mph; and high with a maximum speed of 7 mph. Operate your SmartScoot™ at a reasonable speed for both your personal safety and others. **CAUTION - Do not make turns at high speeds.**

3. Battery Charge Indicator

Located on the upper right side of the control panel is the battery charge indicator. The battery indicator has four levels. When your battery is fully charged, three or four red bar levels will display in red. Over time and usage, these lights will begin to disappear. Once the indicator reaches two red lights consistently, avoid driving and charge the battery as soon as possible.

4. Drive/Reverse Button

The red button with the letter **D** should be pushed to the left to be in the forward function and to the right with the letter **R** for the reverse function. When in the reverse function, an audible beeping will alert you and others that the scooter is in reverse.

5. Horn Button

The green button below the red drive/reverse button is the horn. This button when pushed will emit an audible alert sound.

Light Button Does not operate LED headlight

6. Throttle

The throttle is operated by carefully and slowly twisting the grip towards you, similar to a motorcycle. Always gently turn the throttle when moving from a stopped position to avoid front wheel spin.

7. Disc Brake

The SmartScoot™ is equipped with a disc brake operated with the right hand. To slow or come to a complete stop, release the throttle and squeeze the brake inward.

8. Parking brake

The parking brake is a small black lever located above the far left hand side of the brake. To engage the brake, pull the brake back halfway and at the same time pull back the black lever until you hear a click. Once the parking brake is engaged, the front wheel will not move. To disengage the brake, pull the brake inward and the black lever will snap to the neutral position and the wheel will move freely.

PLEASE NOTE: when not in use, please turn off the switch located on the control box. This will preserve the battery charge.

GETTING STARTED - LEARNING TO DRIVE YOUR SMARTSCOOT™

Just like learning to drive a car or ride a bicycle, operating any personal transportation device inherently includes risk and takes practice. Therefore, use caution as you practice operating the scooter in various situations. Keep the speed at a reduced level until you're comfortable controlling the scooter. The below instructions and practice steps will teach you to maneuver through doorways, on and off lifts, and up and down ramps.

BEFORE YOU TRY DRIVING SMARTSCOOT™

When preparing for your first ride, select an area that is flat, spacious, and away from traffic and other obstacles. Bring a friend along to help you follow the instructions while you practice. Start driving with the lowest speed. Please refer to the Operating Your SmartScoot™ section of this Manual for instructions on the SmartScoot™'s three speeds.

PRACTICE STEPS

Practice the following steps to help you become comfortable with your SmartScoot™.

1. Adjust your SmartScoot™ as instructed in this Manual to fit your body comfortably.
2. Sit on the SmartScoot™ placing your hands on the handlebars and feet on the foot rests.
3. Turn on the SmartScoot™ by pushing the on/off button one time. This will place it in the lowest speed.
4. Learn to use the throttle and brake. With your right hand, apply pressure to the hand brake. Releasing the hand brake, slowly turn the handle (throttle) and move the scooter forward five feet. While releasing the throttle, apply the hand brake and come to a complete stop. Repeat this process several times, each time allowing the scooter to venture farther before applying the hand brake to come to a complete stop. **PLEASE NOTE – SmartScoot™ is a front-wheel-drive scooter. As a result, fast starts can cause its front wheel to spin, which can be dangerous for drivers. Slowly turning the handle each time you start will help to avoid or reduce this condition.**
5. Learn to turn. Slowly turn the SmartScoot™ by using wide movements. Feel how the scooter reacts to your body weight. Shifting your body weight through the turn will help add stability. As you feel more comfortable, you will be able to make the turns tighter. Always remember to slow down before turning or changing directions. Going too fast through a turn will cause the SmartScoot™ to tip over. If the SmartScoot™ begins to tip, slow the unit down and place your feet on the ground.
6. Learn to reverse. Prior to putting SmartScoot™ in reverse, turn your head to make sure there are not people or hazards such as curbs, parked cars or walls behind you. While applying the brake, turn on the reverse function. You will hear a distinct repetitive warning sound.

Turning your head again to ensure that nothing is behind you, release the brake and slowly turn the throttle. Only use the reverse function to move away from an obstacle or back out of an elevator. While in reverse, limit turns or changes in directions.

7. Avoid steep inclines and hills. The SmartScoot™ is not designed to be driven up steep inclines or hills. However, the SmartScoot™ should be able to drive up all wheelchair ramps which comply with government standards. Leaning your body forward, which places more weight on the front wheel, will aid the scooter up the ramp.

GETTING ABOUT WITH YOUR SMARTSCOOT™

While riding your SmartScoot™ you will encounter many situations which will require that you understand the abilities of your scooter. The SmartScoot™ provides reasonable safety on flat and level surfaces but is not entirely fool proof on uneven, slanted or inclined surfaces. Additionally, certain outdoor and indoor conditions can create situations where caution is advised. The following guidelines will help you when encountering certain situations.

URNS

Unlike a two wheeled vehicle, the SmartScoot™ CANNOT be “leaned” into a curve. Therefore, it is essential to slow down to a reasonably slow speed before turning. Use extreme caution when turning on slanted or uneven surfaces. Occasionally you may find yourself negotiating a curve or corner too fast and the inner rear wheel starts to lift off the ground. If this happens, immediately reduce your speed, lessen the steering angle and shift your upper body toward the wheel that is lifting off the ground.



INCLINES AND DECLINES

Incline conditions require special attention to avoid mishaps. The SmartScoot™ is not designed to go up steep or long inclines. Be aware that not all ramps are constructed according to government standards. The government standard for wheelchair ramps is 1 inch (2.5cm) rise per foot (30cm) or 5°.



WARNING – An incline that is too steep or long can create a dangerous situation. The scooter can lose momentum causing it to slide backwards down the incline or tip over backwards. It is not recommended to drive the scooter on any ramp, incline or hill that doesn't meet government wheelchair ramp standards.

Tips for driving the SmartScoot™ on inclines and declines

- Never travel up or down on an incline that is potentially hazardous such as one that is wet, icy, slippery, has loose gravel, etc.
- Always start an incline at the base of the incline.
- Shift your upper body towards the handlebars to shift weight to the front wheel.
- Slowly twist the throttle to move the scooter forward.
- Never stop the scooter on an incline. Do not zigzag, but travel in a straight line to the top.
- If the scooter loses momentum, quickly apply the hand brake and put both feet on the ground. Get off the SmartScoot™ and walk the product either up or down the incline.
- Go very slowly while driving down a ramp. In fact, you can drive down the ramp in neutral without using the throttle.
- Keep your hand on the disc brake handle and slowly apply pressure if the scooter picks up too much speed.

CURBS

The SmartScoot™ should not be driven over any curb. Apply the brake, turn off the scooter and get off the scooter. Lift or walk the scooter around the curb prior to getting back on.

WARNING – Attempting to drive over a curb can cause the product to tip over backwards resulting in possible injury and will cause damage to the scooter. Also use caution when driving on sidewalks near curbs to avoid one wheel falling off the curb. This will cause the scooter to tip over resulting in possible injury.



SPEEDBUMPS AND UNEVEN SURFACES

Generally, the SmartScoot™ can handle slightly uneven surfaces. You should approach each at a reduced speed and in a direct frontal position.

Please keep in mind that the small wheels cannot roll over objects higher than two inches (5cm) and you may fall if you attempt to do so.

WARNING – Attempting to drive over speed bumps or uneven surfaces can cause the product to tip over backwards resulting in possible injury and damage to the scooter.



POTHOLES AND PUDDLES

Avoid all potholes and deep puddles.

WARNING – Attempting to drive over potholes or uneven surfaces can cause the product to tip over backwards resulting in possible injury and will cause damage to the scooter.

INDOOR USE

Similar to an electric wheelchair, you are generally permitted to use the SmartScoot™ inside of buildings, airports, shopping malls, stores, theaters, etc. Doors can be a challenge when using the SmartScoot™. We recommend, when using the SmartScoot™ indoors, that the wheels be in either the narrowest or middle positions. This will enable it to fit through most doors. Approach each door slowly making sure that the rear wheels will make it through the clearance.

OUTDOOR USE

The SmartScoot™ should only be ridden on smooth hard and flat surfaces. It is not designed for off-road conditions. Do not use the SmartScoot™ in rain or snow nor drive it through puddles of water. Slightly uneven surfaces should be approached at a reduced speed and in a direct frontal position and may require lifting or walking the scooter around the surface. Please keep in mind that the small wheels cannot roll over objects higher than two inches (5cm) and you may fall if you attempt to do so. You should not tow anything behind the SmartScoot™.

AIR TRAVEL

When making a reservation, you should always inform the airline that you need special assistance and are travelling with your own electric scooter. If they ask what type of battery you are using, advise them that it is a non-spillable Lithium Ion battery which is airline approved. When arriving at the airport and if you have limited mobility, simply remain on your SmartScoot™ and drive directly to the departure gate. Similarly, with wheelchairs, you should receive preferred treatment at the security checkpoints.

You should identify yourself to the gate agents and ask them to confirm how your SmartScoot™ will be handled from the time you get onto the plane until the time you receive it upon reaching your destination. A gate check tag should be placed on the scooter and you should confirm that the scooter will be brought up to you on the jetway upon your arrival at your destination. Passengers with mobility devices are usually asked to board the airplane first to give the airline handlers enough time to store the SmartScoot™ into the luggage compartment below the plane. Most airlines will want you to drive the SmartScoot™ down the jetway to the entrance of the plane. Once at the entrance of the plane, carefully get off the scooter and remove the battery to place into your carry-on luggage and enter the plane. Upon arriving at your destination, the scooter should be brought up to you on the jetway.

CAUTION – Often times the jetway has a long or steep incline which is not completely flat and there may not be suitable run-up space, which could make driving the scooter on the jetway hazardous. If you find these or other potentially hazardous conditions, either walk the scooter along the jetway or ask airline personnel for assistance.

SMARTSCOOT™

STORAGE ACCESSORIES

SmartScoot™ is more than a mobility scooter. It is also a "helping hand". Our collapsible and removable front basket fits right on the handlebars, making SmartScoot™ a great tool for carrying groceries or other items that you may want to transport. Going on a trip? Our removable luggage bar can accommodate a carry-on type bag. Just place the item on the bar and use a strap or bungee cords to secure it to the handlebars.

BASKET – COLLAPSIBLE AND REMOVABLE

1. Unfold the basket by opening the clasp and lifting the side upward.
2. Add plastic protectors over the hooks to prevent scratching of the metal handlebars. Place the basket on the left side of the handlebars and slide towards the middle.
3. Use fastening screws to secure the basket to the handlebars.
4. Collapse the basket by folding in the front, then the sides. Collapse the folded part onto the back and close the clasp.



LUGGAGE RACK – REMOVABLE

1. Place the rack into the two holes on the bottom of the steering column or under the seat by gently squeezing the sides together.
2. Place carry-on luggage onto the rack when mounted on the steering column. Secure with a strap or bungee cord.
2. Place smaller items under the seat and secure with a strap or bungee cord.



CANE HOLDER

Place the bottom of the cane in the holder located above the front wheel on the left side of the steering column. Secure the cane to the handlebars using a strap or bungee cord.

BATTERY AND BATTERY CHARGING

SmartScoot™ is powered by a 36 volt Lithium Ion battery. Depending on the conditions, the battery can reach up to 12 miles from a single charge. The rechargeable battery can be charged with the battery connected to the scooter or can be easily removed and charged at a different location.

BATTERY INFORMATION

Your SmartScoot™ comes equipped with a 36 volt 8Ah 288 watt Lithium Ion battery.

The battery complies with UN PT. III section 38.3 to meet airline travel requirements. Always turn your SmartScoot™ off before removing and installing your battery. Reconnecting the charger when the batteries are partially discharged or fully charged will not harm them. The battery should be charged after extensive use and when your battery indicator reflects one or two red lights.

Battery range depends on operator weight, terrain and the condition of the battery. Charge the battery as needed shown by the battery indicator lights.

CHARGING THE BATTERY

- Charge your SmartScoot™ only with the included charger or the spare charger from SmartScoot™. Use of any other chargers may damage the battery and will void the warranty.
- Your SmartScoot™ battery can be charged connected to the SmartScoot™, or disconnected and charged at a location away from the scooter,
- To charge the battery while connected to the scooter, plug the charging connector into the charging socket and then connect the charger to an appropriate electrical socket.
- To charge the battery while disconnected from the scooter, slide the battery holder latch and pull out the battery cord. Carefully slide up the battery pack and remove. Plug the charging connector into the charging socket and connect the charger to an appropriate electrical socket.
- Do not use non-standard power sources, such as generators or inverters, even if the voltage and frequency appear acceptable. Only use AC power provided by a standard wall outlet.
- During charging, the indicator light on the charger will be red. When the battery is at full charge, the indicator light will turn green.
- The initial charge is around 5 hours. After the initial charge, it should take only an hour or so to fully recharge the battery. However, charging times depend on the level of charge needed at the time of charging.

PLEASE NOTE - To prolong the battery life, recharge it at least once every three months.

CAUTION – Only use the SmartScoot™ charging cord which comes packed with your SmartScoot™ to charge the SmartScoot™ as directed in this Manual.

HOW TO INTERPRET THE BATTERY INDICATOR LIGHTS ON THE CONTROL PANEL

The battery indicator has four levels indicated by red lights. When your battery is fully charged, there will be three or four levels indicated by red lights. Over time and usage, these lights will begin to disappear. Once the indicator reaches two red lights consistently, charge the battery as soon as possible.

BATTERY CARE

Before storing the battery, it should be fully charged and should be recharged at least once every three months.

Store the battery indoors in a dry environment.

Storage temperature range: -4° F (-20°C) to 104°F (40°C)

Charging temperature range: 32°F (0°C) to 104°F (40°C)

Operating temperature range: -4°F (-20°C) to 122°F (50°C)

WARNING – Do not attempt to remove the cover of the battery. Removing the battery cover will invalidate your battery warranty.

WARNING – Improper use and/or care of battery may result in explosion, fire, or shock. Do not heat, open, puncture, mutilate, expose to water/rain/moisture, or dispose of the battery in fire. Do not leave the battery in direct sunlight for an extended period of time or leave the battery in a hot car. Do not place the battery near a heat source, like a fireplace, heater, etc.

WARNING – Do not use the SmartScoot™ in areas with potentially explosive atmospheres, including but not limited to, areas such as fueling areas, fuel or chemical transfer or storage facilities, or areas where the air contains chemical or particles, such as grain dust, or metal powders. In such areas, sparks can occur and cause an explosion or fire.

WARNING – Please also read and follow the battery Operating Instructions.

PRODUCT SPECIFICATIONS

Model S1200

Specifications	Details
Scooter Size Setup	39" H x 38" L x 22" W
Scooter Size Folded with Seat	30.5" H x 38" L x 22" W
Scooter Size Folded without Seat	17" H x 38" L x 22" W
Scooter Weight Complete	39.5lbs Heaviest part = 27 lbs
Seat Weight	8.5 lbs
Battery Weight	4 lbs
Maximum Load Weight	250 lbs Loaded or 113.40 kg
Scooter Speeds	3, 5 and 7 mph
Ground Clearance	9" Front - 3" Rear
Battery	36V, 8 amp hr 288-watt Li-Ion Rechargeable
Battery Certification	UN PT. III 38.3 for Airline Travel
Battery Charger	Input Voltage: AC100V-240V
Battery Charging Time	~5 Hours
Frame Materials	Stainless Steel
Brakes	Front Disk Brake
Drive	Front Wheel Drive

LIMITED WARRANTY

LIMITED WARRANTY

IMP Holdings, LLC, SmartScoot™ (IMP) warrants your SmartScoot™ against defects in materials and workmanship from the date of the original retail purchase as follows:

2 Year Limited Warranty: Structural Frame under normal use conditions.

1 Year Limited Warranty: All components, including motor, brakes, electrical, and axles under normal use conditions.

1 Year Limited Warranty: Battery under normal use conditions.

This limited warranty extends only to the original owner and is not transferable to anyone else.

If a defect exists, IMP will, at its option and to the extent permitted by law either (1) provide components to repair the SmartScoot™ using new or refurbished parts at no charge to you; (2) exchange the SmartScoot™ with a functionally equivalent product that is new or refurbished; or (3) refund the original purchase price. After repair or replacement, the SmartScoot™/functionally equivalent product will be covered by this limited warranty for the longer of the remainder of the original limited warranty period, or 90 days after IMP ships the SmartScoot™/functionally equivalent product to you. IMP's responsibility to repair or replace the SmartScoot™, or to refund the purchase price, is your exclusive remedy. This warranty excludes damage caused by abuse, misuse, accidents, unauthorized repairs, alterations, modifications, failure to follow instructions in the User's Instruction Manual and battery Operating Instruction, or other causes that are not defects in materials and workmanship for which IMP is responsible.

This Limited Warranty does not cover parts which may, under normal wear and tear, require replacement including, without limitation, tires, upholstery, fuses, etc.

TO THE EXTENT PERMITTED BY APPLICABLE LAW, IMP IS NOT LIABLE FOR ANY DIRECT, INDIRECT, INCIDENTAL, SPECIAL, OR CONSEQUENTIAL DAMAGES ARISING OUT OF THE USE OR SERVICE OF THE SMARTSCOOT™. THE WARRANTY AND REMEDIES STATED ABOVE ARE EXCLUSIVE AND IN LIEU OF ALL OTHER WARRANTIES, REMEDIES OR CONDITIONS, WHETHER ORAL, WRITTEN, EXPRESS, STATUTORY, OR IMPLIED TO THE EXTENT PERMITTED BY APPLICABLE LAW. IMP SPECIFICALLY DISCLAIMS ALL IMPLIED AND STATUTORY WARRANTIES INCLUDING, WITHOUT LIMITATION, WARRANTIES OF MERCHANTABILITY AND FITNESS FOR A PARTICULAR PURPOSE. IF IMPLIED WARRANTIES CANNOT BE DISCLAIMED, SUCH WARRANTIES ARE LIMITED IN DURATION TO THE DURATION OF THIS WARRANTY. Any recovery is limited to the original purchase price. No person is authorized to modify this Limited Warranty.

THIS WARRANTY DOES NOT AFFECT YOUR STATUTORY RIGHTS.

Some states do not allow limitations on how long an implied warranty lasts, or exclusions of incidental or consequential damages and the above limitations may not apply to you. This Limited Warranty gives you specific legal rights. You may have other rights, which vary from state to state.

This warranty and all lawsuits, disputes, and claims will be governed by and interpreted under the laws of the State of Georgia, regardless of any conflict of law principles. The parties also irrevocably consent to the jurisdiction of the State Court of Fulton County, Georgia, and agree that the State Court of Fulton County, Georgia shall have exclusive jurisdiction and be the sole venue for the consideration of any lawsuits, disputes, and claims between the parties.

The parties hereby waive the right to any jury trial on any lawsuit, dispute, claim, or controversy. The parties also waive any right to consolidate or to have handled as a class action any proceeding on any lawsuit, dispute, claim, or controversy. The parties agree that any proceedings will be conducted solely on an individual basis. The parties agree not to seek to have any lawsuit, dispute, claim, or controversy heard as a class action, private attorney general action, or in any other proceeding in which either party acts or proposes to act in a representative capacity.

If any provision herein is found to be illegal or unenforceable, that provision will be severed with the remaining in full force and effect.

Return Policy: If you disagree with any of the terms and conditions herein, you must submit a written request to info@SmartScoot.com for a Return Authorization within 3 days of delivery. Do not unpack or assemble the SmartScoot™. The scooter must be returned in its original box and in new and unused condition, accompanied by the original receipt. All other returns must be made within 14 days of delivery and only in “as new” condition. The customer is responsible for all shipping costs including incidental shipping damage caused by improper packing. A Return Authorization must be made by written request to info@SmartScoot.com and the return must be accompanied by the original receipt. The scooter must be returned in its original box. All returns are subject a 10% restocking fee.

TROUBLESHOOTING AND MAINTENANCE

Your SmartScoot™ has been designed to be almost maintenance and service free. SmartScoot™ uses self-lubricating bearings throughout the scooter and the frame is constructed using stainless steel. In addition, all parts can be cleaned with general cleaning agents. However, there are a few maintenance items that may require your attention from time to time. The following are the most likely adjustments that might be needed.

PLEASE NOTE -- If you are having difficulty with any of these adjustments, your local bicycle shop is a good resource. The SmartScoot™ and bikes have similar componentry.

STEERING COLUMN AND FRONT WHEEL ALIGNMENT

If your front wheel is not perfectly lined up with your handlebars, then you need to make an adjustment to the front wheel lock mechanism. To adjust:

1. Using our Fold n Lock™ Technology, fold down the front steering column by lifting the front lever and pulling the latch down through the notch and clamp. With one hand on the steering column use one finger from your opposite hand to slide the latch sideways until the steering column releases.
2. Use a 6mm Allen wrench to loosen the center screw from the front wheel lock mechanism.
3. After the screw is loosened from the front wheel, adjustments can be made and aligned as needed.
4. After adjustment, fully re-tighten the screw to secure the alignment.
5. The steering locking system and front wheel assembly may loosen with use. Check this frequently and tighten whenever loosened.

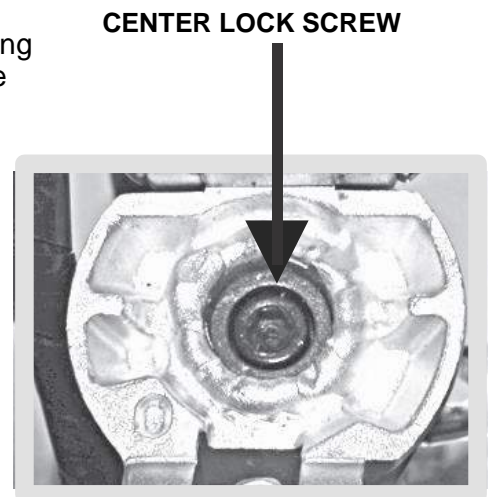

DISC BRAKE ADJUSTMENT

If you determine that you are not stopping quickly enough or your stopping distance has increased when you fully engage the brake lever, you can adjust the clamping pressure on your disc brakes or adjust the disc brake actuator. Before performing the “clamping pressure adjustment”, make sure that the brake actuator is fully engaged when the brake lever is fully depressed. This can be checked by fully depressing the brake lever and checking to make sure that additional actuator movement is not possible by moving the actuator by hand.

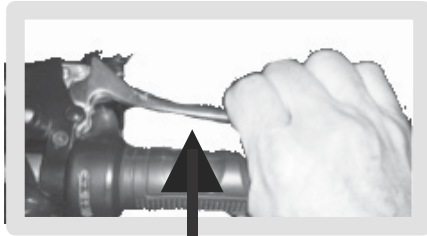

BRAKE LEVER ENGAGED

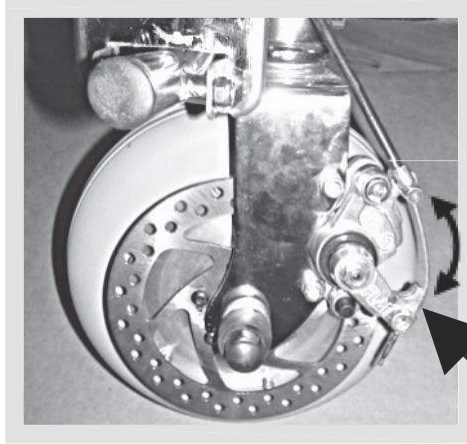

**ACTUATOR
MOVEMENT WHEN
BRAKE LEVER IS
DEPRESSED**

ACTUATOR

If the actuator is not fully engaged, (additional movement is possible by moving the actuator by hand when the brake lever is fully depressed) and the hand movement of the actuator causes the front wheel to become locked, then see Disc Brake Level Adjustment section below. The brake pressure adjustment should not be necessary because the cable has slipped or stretched over time. If this is not the case, then adjust the braking pressure.

1. Locate the adjustment nut and screw on the disc brake. The main adjustment to increase braking pressure is done by loosening the nut (10mm) and using a 3mm Allen wrench turning the screw very slightly clockwise. Note: very small adjustments (1/8 to 1/4 turns) should be made so that you do not provide too much braking pressure. Spinning the wheel and engaging the brake level will indicate when you have provided enough adjustment
2. After adjustment then fully re-tighten the nut to secure the adjustment.
3. The adjustment knob can also be used to reduce "brake drag" noise. Simply turn the knob to reduce noise as much as possible. Note: some brake drag noise could be noticed especially after performing a brake pressure adjustment. If you cannot fully adjust the noise, the noise should gradually disappear with usage.

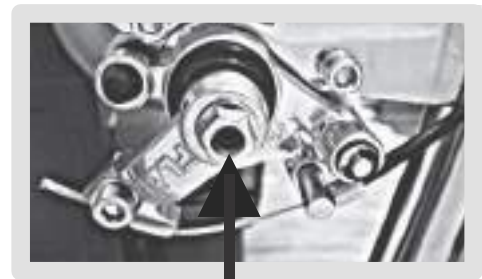

NUT AND SCREW

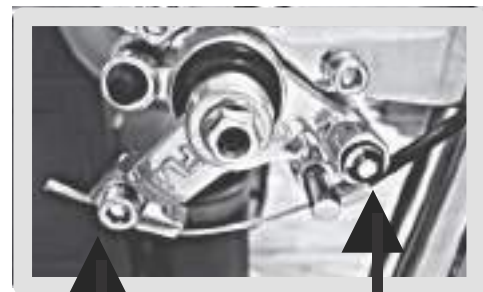

KNOB

CABLE LOCK SCREW

PLEASE NOTE – It is very important that you do not loosen or reduce your braking capability as that may lead to a serious accident.

DISC BRAKE LEVEL AND TRAVEL ACTUATOR ADJUSTMENT

1. Locate the cable lock screw, as pictured above.
2. Loosen the screw then slide the actuator along the cable counter clockwise to move the cable.
3. Tighten the screw and check to make sure that when the brake level is fully engaged the wheel does not turn, and when the brake level is released that the wheel turns freely.
4. After adjustment, fully re-tighten the nut to secure the adjustment.

NO POWER TO THE CONTROL PANEL

If you have no power to the control panel located on the handle bar check the following:

1. Check to see if the power switch is turned to the on position.
2. Check to see if the battery needs charging.
3. Check to make sure the battery connection is fully plugged in.
3. If the problem persists, contact SmartScoot™

NO POWER AFTER TWISTING THE THROTTLE

1. Check to see if the parking brake is on and if so, disengage the parking brake by pulling in the brake handle and releasing it.
2. Check to see if there is a speed indicated on the speed control. If there is no speed indicated, choose a speed by pressing the green mode button.

COMMENTS ON THE BATTERY

Your SmartScoot™ comes with a top grade Lithium Ion battery to provide abundant power in a very light weight package. Like all rechargeable batteries, this battery will "wear out" over time and with usage. If this happens, you will notice that the battery life of the distance travelled between recharging will decrease and the charging time will lessen. You may also note the fourth indicator red light on the control panel no longer illuminates after charging. This is to be expected and it does not mean you have a defective battery. This does mean that the battery life is decreasing and you may need a replacement battery in the near future.

CUSTOMER SUPPORT

Any questions regarding any information contained in this section, any other section of this Manual, our website, any support materials, or any other general questions should be sent in writing to info@SmartScoot.com or called in to our customer service representatives at (855) 726-6866/ (855)-SCOOT66.